

Battery Maintenance



9006 - 6/2 Amp, 6/12 Volt Manual Economy Charger

- From 4 to 6 times the power of 9002, but capable of charging small batteries
- Great value for its performance



9010 - 10/2 Amp, 6/12 Volt Manual Full-Rate Charger

- Ideal for charging average battery in 3 to 5 hours
- At least 50% more power than # 9006
- Safely charges small batteries on 2 amp setting



9014 - 10/2 Amp, 6/12 Volt Automatic Full-Rate Charger

- Automatic 12 volt settings turn charger off when battery is full
- Reduces risk of overcharging
- Manual 6 volt position for lower voltage requirements
- Great for standard, maintenance-free, deep-cycle, and small batteries



Part #	Description	Size
CC 412ULAC 25 6157	W/500A Clamp	12' 12'
CC 20420AC 25 6160 25 6161	W/500A Clamp W/800A Clamp	20' 20' 20'
US B0425UL		25'



9002 - 1.5 Amp, 12 Volt Automatic Charger / Maintainer

- For all vehicles, can be mounted
- Fully automatic with charging status indicated by LED
- Reverse polarity and short circuit protection



9060 - 10/2/55 Amp, 6/12 Volt Automatic Charger w/engine starter

- Automatic 12 volt settings turn off at full charge and turn back on if battery needs more power
- Green LED signals "complete charge", Red LED indicates "reverse hook-up"
- Separate selection for starting vehicle
- Manual 6 volt position for lower voltage requirements



6031 Alternator-Battery Tester - 125 Amp

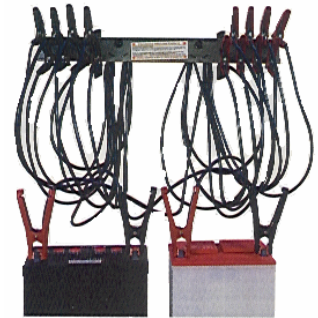

6075 - Parallel Bus Bar Charging Station

Booster Clamps



Clamp Sets
6199 - 400 Amp
6202 - 500 Amp
6205 - 800 Amp



6139 + 6146 Polarized Power Sockets With 25' Cables



6065 30 Amp Parallel Multiple Battery Charger



- 6021** - 6/12 volt w/load tester
- 50/50/5 Amp
 - 200 Amp Cranking Assist
 - UL + cUL listed for indoor + outdoor
 - Built-in 125 amp fixed load tester
 - Dual meters for enhanced operational knowledge
 - Fan cooled
 - 5 year warranty
 - Made in USA



6001A Booster - Charger
6/12 Volt - 550 Amp



6002B Booster - Charger
6/12/18/24 Volt
600 Amp



6006 6/12 Volt Fast Charger



6009 Booster - Charger
6/12 Volt - 230 Amp

Battery Maintenance

Rev. 12-20-2004



Portable Battery Chargers With Engine Start

Solar 1050
10/2/55**-amp, 6/12-volt
Manual battery charger and engine starter



- Excellent full-power charger
- Charge standard, maintenance-free, deep-cycle, and small-engine batteries
- Minimal pre-charging needed to help start vehicles with weak batteries

Solar 1050
10/2/55**-amp, 6/12-volt
Manual battery charger and engine starter

- Excellent full-power charger
- Charge standard, maintenance-free, deep-cycle, and small-engine batteries
- Minimal pre-charging needed to help start vehicles with weak batteries

Booster Pacs



Part #	Description
ES1224	12v/24v 2000 peak amps
ES2500	12v, 900 peak amps Lightweight, 1-5 jumps 23" cables
ES5000	12v, 1500 peak amps H/D, 43" cables
ES6000	12v, 1200 peak amps X/Long cables 15-20 jumps
ES8000	24v, 1600 & 3200 peak amps

Replacement Batteries

Part #	Description
ES1217	2500, 4000, 8000
ES1240	6000, 7000

Wheel Type Charger / Starters

Solar 560
60-amp, 6/12-volt Charger • Starter • Tester

Added power, added features:

- 2-hour timer automatically turns charger off when time is up
- Special meter lights mean less guesswork
- Red light indicates reverse hookup
- Green light signals a fully charged battery



- Tester easily checks percentage of charge, alternator performance and problem battery conditions, such as shorted or sulfated batteries

Solar 580
Manual-to-automatic, 60-amp, 6/12-volt Charger • Starter • Tester
Includes the ultimate in features and control:

- Fully automatic mode stops charging battery at full charge; turns ON and OFF as needed
- Ideal for extended charging or maintaining battery at full charge ... Begin charging in this mode, or allow timer to switch charger to this mode
- 2-hour timer – select up to two hours of manual charging time ... Switches to 10-amp, fully automatic charge when time is up
- Infinite amperage control – select ANY charge rate up to 60 amps
- Test feature tests battery for percent-of-charge
- Test alternator performance ... Test for problem conditions, such as sulfated or shorted batteries



Portable Battery Chargers

Solar 1007
6/12-amp, 6/12-volt manual, economy battery charger

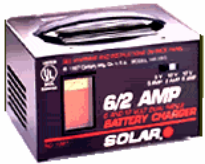

- Charging versatility at a low price
- Charge standard, maintenance-free, deep-cycle, and small-engine batteries

Solar 1014
10/2-amp, 6/12-volt, automatic-taper, high-rate battery charger
Comes Complete:



- Automatic 12-volt settings taper output to less than one amp as full charge is reached
- Greatly reduces risk of overcharging
 - Manual, 6-volt setting for your 6-volt charging applications
 - Charge standard, maintenance-free, deep-cycle, and small-engine batteries

Solar 1010
10/2 Amp, 6/12 -volt manual, high-rate battery charger



- Excellent full-power charger
- Charge standard, maintenance-free, deep-cycle, and small-engine

Solar 670
60-amp, 6/12/24-volt
Charger • Starter
Rugged and versatile fleet charger

- 24-volt charging
- 2-hour timer automatically turns charger off when time is up
- Extra-large ammeter and voltmeter help you easily monitor charging progress
- Extra-long, 8-foot cables for hard-to-reach batteries. Heavy-duty cables stay flexible to -25° F.
- Chrome, tubular Handle



* TRUCK * BUS * TRAILER PARTS *
* CONTRACTOR SUPPLIES * NUTS & BOLTS *
Phone# (201) 797-9490

Battery Maintenance

Refractometer

Tests
Batteries &
Anti-Freeze



EZ EZB108 - EZ Red

Ensures adequate freeze and boil-over protection by testing the freeze point of anti-freeze solutions.

Also accurately determines the state of charge for electrolyte in lead-free batteries.

Battery Testers



Z3 9-1299
Battery Tester
Mini
Floating balls indicate
battery condition



DK 00199
Battery Hydrometer
Professional
Float tests battery
fluid condition



DK 00231
Battery Hydrometer
W/Temperature
Compensation
Tests battery fluid
conditions

DK 00198
Battery Tester
W/Dial Indicator
Dial indicates
battery charge



EZ B1100

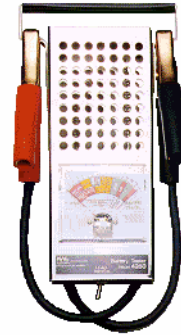

H/D Copper Plated Clamps
100 Amp Capacity
Load Safety Switch
For 6 & 12 Volt Batteries
Tests: Voltage Supply,
Cranking Volts, Charging Volts
and Good/Bad Battery Test

Battery Filler Bulb
DK 00257



SG 120154-001
Battery Carrier



Battery Terminal Brush
Metal - DK 00254
Plastic - KG 201



DK 00256
Terminal
Puller



P6 319
Terminal
Spreader



PW 75-030
Battery Filler



DK 00253
Battery Tray
11-1/2" x 8-1/2"



Good-All

GS 11-716KVC - Start-All - 600A, 16 HP

- Super duty unit for starting diesel trucks and heavy equipment with 24 volt, 12/24 volt, and 12 volt ignition systems.
- Has two complete boosting systems, voltage control installed on one set of cables.
- Engine: 16 hp, 4 cycle, cast iron Kohler
- Starter: Positive 12 volt electric start
- Cable: Two sets of #2 ga. duplex welding cable, 30' long with 500 amp clamps



NOCO



NK A202
Spray
Protector

NK C704
Terminal
Pad
Protectors



(Can/100)

NK E404
Spray
Cleaner
& Acid
Detector



Battery Boxes

DK 03009
Group 24
11" x 6-3/4" x 8"



DK 03189
Group 24-30
13-5/8" x 7" x 8"

* TRUCK * BUS * TRAILER PARTS *
* CONTRACTOR SUPPLIES * NUTS & BOLTS *
Phone# (201) 797-9490



Battery Maintenance

New 06-06-2006

Battery Hold Down Bolts (Chrome finish)

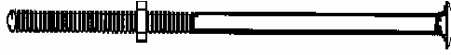

Part #	Dia/TPI	Length	Thrd.Lgh	Type
D6 390-001	5/16-18	12"	2-1/4	1

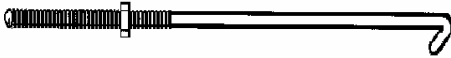

Part #	Dia/TPI	Length	Thrd.Lgh	Type
D6 390-011	1/4-20	4-3/4	2-1/4	2
D6 390-014	1/4-20	7"	2-1/4	2
D6 390-012	1/4-20	8-1/2	2-1/4	2
D6 390-004	5/16-18	8"	1	2
D6 390-005	5/16-18	10"	2-3/4	2
D6 390-019	5/16-18	10-7/8	2-1/8	2
D6 390-002	3/8-16	10	3"	2

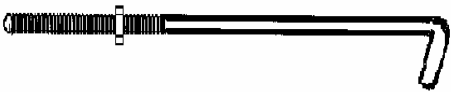

Part #	Dia/TPI	Length	Thrd.Lgh	Type
D6 390-016	1/4-20	8-3/4	2-1/2	3
D6 390-006	5/16-18	5-1/2	2-1/4	3
D6 390-015	5/16-18	8-3/4	2-1/4	3

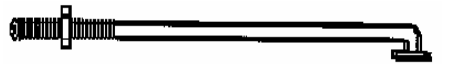

Part #	Dia/TPI	Length	Thrd.Lgh	Type
D6 390-010	5/16-18	7	1-1/4	4
D6 390-009	3/8-16	10-1/4	1-1/2	4

Ground Straps 4 Ga. Braided Copper



Length	Engine to Ground	Length	Battery to Ground
8"	KM 8E	7"	KM 7D
12"	KM 12E	9"	KM 9D
14"	KM 14E	11"	KM 11D
18"	KM 18E	13"	KM 13D
		16"	KM 16D
		19"	KM 19D
		23"	KM 23D
		27"	KM 27D

Battery Hold Downs



DK 00250
Adjustable to 6-7/8"



Part #	Description
DK 06159	Group 24, 6-7/8" x 10-1/4"
DK 06160	Group 27, 6-7/8" x 12-1/16"
DK 06165	Group 31, 6-7/8" x 13-1/16"
DK 06166	Group 31, 13-1/8" x 13-5/8"

Charging Connectors



Part #	Description
KM 819	Pin Type Charging Connector
KM 820	Cup Type Charging Connector

Alligator / Charging Clips

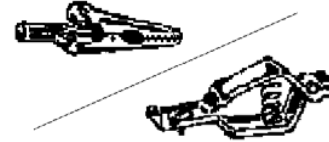

Part #	Description
HL 325B	Alligator Clip, Insulated, Black
HL 325R	Alligator Clip, Insulated, Red
KM 815	Alligator Clip, Non-Insulated
KM 816	Charging Clip, 10 amp
KM 817	Charging Clip, 25 amp
KM 818	Charging Clip, 30 amp

Battery Cables

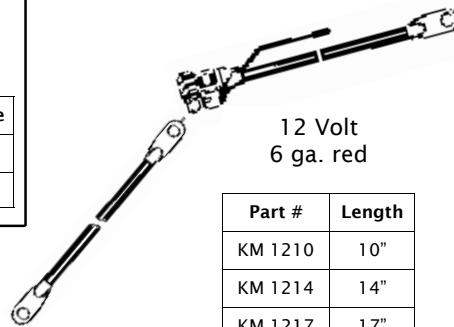

12 Volt
6 ga. red

Part #	Length
KM 1210	10"
KM 1214	14"
KM 1217	17"
KM 1220	20"
KM 1224	24"
KM 1227	27"
KM 1231	31"
KM 1234	34"
KM 1238	38"
KM 1242	42"
KM 1248	48"
KM 1272	72"
KM 536C	53"

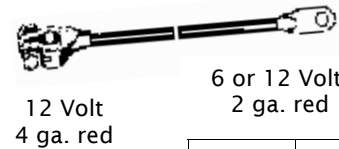

12 Volt
4 ga. red

Part #	Length
KM 10S	10"
KM 14S	14"
KM 20S	20"
KM 24S	24"
KM 27S	27"
KM 31S	31"
KM 34S	34"
KM 38S	38"
KM 43S	43"
KM 48S	48"
KM 53S	53"
KM 58S	58"
KM 65S	65"
KM 72S	72"

6 or 12 Volt
2 ga. red

Part #	Length
KM 10S2	10"
KM 14S2	14"
KM 19S2	19"
KM 24S2	24"
KM 27S2	27"
KM 31S2	31"
KM 38S2	38"
KM 42S2	42"
KM 48S2	48"
KM 53S2	53"
KM 65S2	65"
KM 72S2	72"

Switch to Starter
Cables
4 ga,
3/32 stud holes

Part #	Length
KM 15SS	15"
KM 18SS	18"
KM 24SS	24"
KM 32SS	32"
KM 42SS	42"
KM 49SS	49"

* TRUCK * BUS * TRAILER PARTS *
* CONTRACTOR SUPPLIES * NUTS & BOLTS *
Phone# (201) 797-9490

Lead Battery Terminals

Emergency w/bolt & nut

Part #	Description	Cable Size
KM 804	Universal, Regular	6 to 2/O Ga.
KM 888	Universal, H/D	1 to 4/O Ga.



Side Terminal Adapter

Part #	Description
DK 05411	Stud to Post (Positive)
DK 05412	Stud to Post (Negative)



Emergency Type, Side Mount

Part #	Description
DK 05303	Universal, 3/8" Bolt



Military

Part #	Description
KM 870N	Negative
KM 870P	Positive



Marine Wing Nut

Part #	Description
DK 05308	Positive - 3/8" Wing Nut
DK 05309	Negative - 5/16" Wing Nut



Top Post Adapter

Part #	Description
VV 058017	Adapter, Stud to Post (pair)



Brass Battery Terminals

Standard Elbow Terminal

Part #	Type	Gauge
KM 801	Universal	1 & 1/0



Split Barrel Terminal

Part #	Type	Gauge
KM 802	Universal	2 & 1
KM 806	Universal	1/0 - 2/0
KM 860N	Negative	2/0 - 3/0
KM 860P	Positive	2/0 - 3/0



Straight Barrel Terminal

Part #	Type	Gauge
KM 803	Universal	6 & 4



* TRUCK * BUS * TRAILER PARTS *
 * CONTRACTOR SUPPLIES * NUTS & BOLTS *
 Phone# (201) 797-9490

Battery Maintenance

Starter Cable



- * Pure copper cable, finely stranded for flexibility.
- * Insulation won't melt when in contact with hot engine parts.
- * Insulation temperature rating 110°C (230°F).

SG 6014
 Sq. head bolt
 W/Shoulder nut
 5/16-18
 x
 1-3/8" Long



SG 6015
 S/Steel Battery nut
 3/8-16



SG 6703
 Side Term. Bolt
 3/8-16 x 13/32



SG 6704
 Side Term. Bolt
 3/8-16 x 1" Long

100 ft. Part #	Gauge	Color
CAO 139025B	1/0	BLACK
CAO 139025R	1/0	RED
CAO 130025B	2/0	BLACK
CAO 130025R	2/0	RED
CAO 139325R	3/0	BLACK
VV 058245	3/0	RED
CAO 139525B	4/0	BLACK
VV 058247	4/0	RED
CAO 139125B	1	BLACK
CAO 139125R	1	RED
CAO 139225B	2	BLACK
CAO 139225R	2	RED
CAO 1394100B	4	BLACK
CAO 1394100R	4	RED
CAO 1396100B	6	BLACK
CAO 1396100R	6	RED

Black Split Loom

Part#	Inside Dia.
VV 020104	1/4"
QP CL55	3/8"
QP CL65	7/16"
VV 020108	1/2"
QP CL105	5/8"
QP CL115	3/4"
QP CL125	1"
VV 020117	1 1/16"
VV 020117-7	1 1/4"
VV 020118-7	1 1/2"
VV 020119-7	1 7/8"

Protect your wires and wiring. Split seam allows easy insertion and removal without disconnecting the wire or cable.



Battery Maintenance

New 04-08-2006

Crimp Connectors

Copper Lugs And Butt Connectors Crimp or Solder



Lug Size	8 Gauge	6 Gauge	4 Gauge	2 Gauge	1 Gauge	1/0 Gauge	2/0 Gauge	3/0 Gauge	4/0 Gauge
#10	28 8101	28 6101							
1/4"	28 8141	28 6142	28 4141	28 2141	28 1141	28 10141	28 20141	28 30141	28 40141
5/16"	28 8562	28 6562	28 4562	28 2561	28 1561	28 10561	28 20561	28 30561	28 40561
3/8"	28 8382	28 6382	28 4382	28 2381	28 1381	28 10381	28 20381	28 30381	28 40382
1/2"	28 8503	28 6503	28 4503	28 2503	28 1503	28 10503	28 20501	28 30501	28 40502
Butt Connectors	28 8001	28 6001	28 4001	28 2001	28 1001	28 10001	28 20001	28 30001	28 40001

Quick Connectors - Copper Die Cast



Straight Clamp

Cable Size	Negative	Positive	Universal
6			SG 4006U
4			SG 4004U
2			SG 4002U
1	SG 4001N	SG 4001P	SG 4001U
1/0	SG 4010N	SG 4010P	
2/0	SG 4020N	SG 4020P	
3/0	SG 4030N	SG 4030P	
4/0	SG 4040N	SG 4040P	



Right Elbow Left Elbow

Cable Size	Negative Right	Positive Right
1/0	SG 4110N	SG 4110P
2/0	SG 4120N	SG 4120P
3/0	SG 4130N	SG 4130P
4/0	SG 4140N	SG 4140P

Cable Size	Negative Left	Positive Left
1/0	SG 4210N	SG 4210P
2/0	SG 4220N	SG 4220P
3/0	SG 4230N	SG 4230P
4/0	SG 4240N	SG 4240P



Flag Connector

Cable Size	Negative	Positive
1/0	SG 4310N	SG 4310P
2/0	SG 4320N	SG 4320P
3/0	SG 4330N	SG 4330P
4/0	SG 4340N	SG 4340P

Magna Lug Connectors



Size	1/4" Stud	5/16" Stud	3/8" Stud	1/2" Stud
8	SG 6408D	SG 6408E	SG 6408F	
6	SG 6406D	SG 6406E	SG 6406F	
4	SG 6404D	SG 6404E	SG 6404F	SG 6404H
1&2	SG 6401D	SG 6401E	SG 6401F	SG 6401H
1/0	SG 6410D	SG 6410E	SG 6410F	SG 6410H
2/0	SG 6420D	SG 6420E	SG 6420F	SG 6420H
3/0	SG 6430D	SG 6430E	SG 6430F	SG 6430H
4/0	SG 6440D	SG 6440E	SG 6440F	SG 6440H

Magna Splice



Size	Part #1
4	SG 6804
1 + 2	SG 6801
1/0	SG 6810
2/0	SG 6820
3/0	SG 6830
4/0	SG 6840



SG 4285-001 24" pro wire cutter, 8-6/0 ga

SG 4275-001 9" wire cutter 8-2/0 ga



SG 4255-001 Hex Crimper, 8-6/0 ga



SG 4247-001 Jr. Crimper, 8-1 ga



SG 4245-001 Cub Crimper 10-1 ga



SG 4266-001 Hammer Crimper 8-4/0 ga

Magna Lug 45° & 90° Connectors



Magna Lug 3/8" Elbows



Size	45° Lug 3/8" Stud	45° Lug 1/2" Stud	90° Lug 3/8" Stud	90° Lug 1/2" Stud
8	SG 6408FV		SG 6408FL	
6	SG 6406FV		SG 6406FL	
4	SG 6404FV	SG 6404HV	SG 6404FL	SG 6404HL
1&2	SG 6401FV	SG 6401HV	SG 6401FL	SG 6401HL
1/0	SG 6410FV	SG 6410HV	SG 6410FL	SG 6410HL
2/0	SG 6420FV	SG 6420HV	SG 6420FL	SG 6420HL
3/0	SG 6430FV	SG 6430HV	SG 6430FL	SG 6430HL
4/0	SG 6440FV	SG 6440HV	SG 6440FL	SG 6440HL

Size	3/8" Stud	1/2" Stud
8		
6		
4		
1&2		
1/0	SG 6311F	SG 6321F
2/0	SG 6312F	SG 6322F
3/0	SG 6313F	SG 6323F
4/0	SG 6314F	SG 6324F

* TRUCK * BUS * TRAILER PARTS *
* CONTRACTOR SUPPLIES * NUTS & BOLTS *
Phone# (201) 797-9490